

Model : ALP045-R

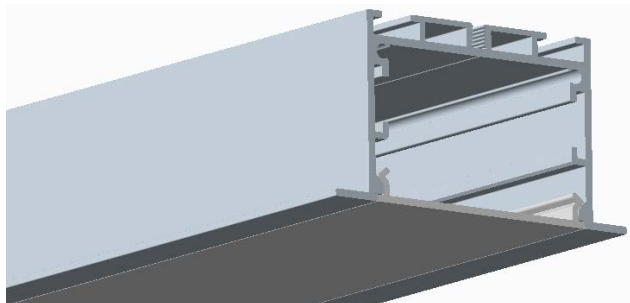

Dimension

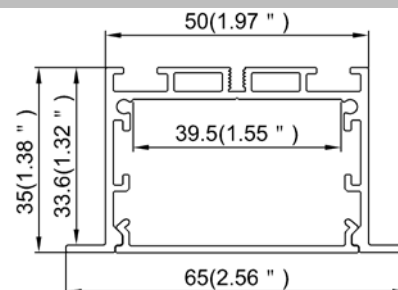

Specification

Aluminum Profile	6063-T5
Diffuser	PC diffused cover
Length	2000mm / 2500mm / 3000mm
Weight	0.918kg/m
Max LED Strip Width	38mm
Max Power	30W/m
Beam angle	100°
Finish	Silver / Black anodized , Powder coated white / black or other colors
Installation	Recessed

Accessories

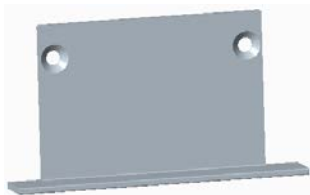

End Cap(Metal)



LED Strip



Stainless Clip (Metal)



180° Connector(Metal)



90° Connector(Metal)



90° Vertical Connector(Metal)

Steps of Installation

1. Stick the LED strip

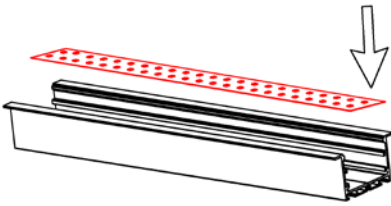

2. Click the diffused cover

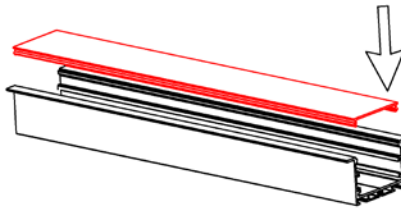

3. Fix the spring clip

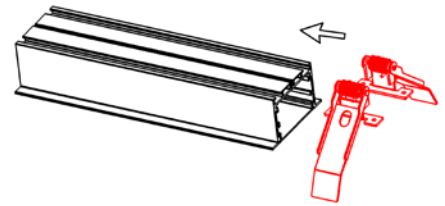

4. Tighten the spring clip with screw

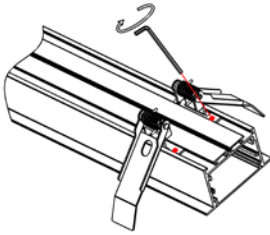

5. Installing the end caps with screws

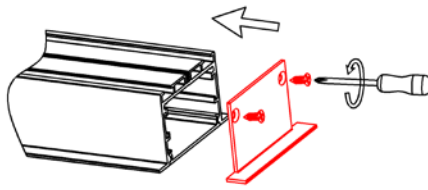

6. Insert the fixture to the plasterboard

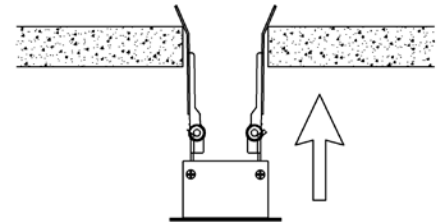

1. Installation completed

